



## OPERATING MANUAL

### K II Series Induction Motor Single-phase 110/115 V, 220/230 V type



### Introduction

#### ■ Before using the motor

Only qualified and educated personnel should work with the product. Use the product correctly after thoroughly reading the section "Safety precautions." Should you require the inspection or repair of internal parts, contact the Oriental Motor office where you purchased the product. The product described in this manual has been designed and manufactured to be incorporated in general industrial equipment. Do not use for any other purpose. Oriental Motor Co., Ltd. is not responsible for any damage caused through failure to observe this warning.

#### ■ Standard and CE Marking

- This product is recognized by UL under the UL and CSA standards. Also, it conforms to the China Compulsory Certification System (CCC System). The motor model name is the recognized product name.
- The motor is affixed the CE Marking under the Low Voltage Directive.

Refer to p.4 for details.

#### ■ Hazardous substances

The products do not contain the substances exceeding the restriction values of RoHS Directive (2011/65/EU).

### Safety precautions

The precautions described below are intended to prevent danger or injury to the user and other personnel through safe, correct use of the product. Use the product only after carefully reading and fully understanding these instructions.



Handling the product without observing the instructions that accompany a "Warning" symbol may result in serious injury or death.

- Do not use the product in explosive or corrosive environments, in the presence of flammable gases, or near combustibles. Doing so may result in fire, electric shock or injury.
- Only qualified and educated personnel should be allowed to perform installation, connection, operation and inspection/troubleshooting of the product. Handling by unqualified and uneducated personnel may result in fire, electric shock, injury or equipment damage.
- Do not transport, install the product, perform connections or inspections when the power is on. Always turn the power off before carrying out these operations. Failure to do so may result in electric shock.
- Turn off the power in the event the overheat protection device (thermal protector) is triggered. Failure to do so may result in injury or damage to equipment, since the motor will start abruptly when the overheat protection device (thermal protector) is automatically reset.
- The motor is Class I equipment. Install the motor so as to avoid contact with hands, or ground it to prevent the risk of electric shock.
- Keep the input power voltage within the specified range. Failure to do so may result in fire or electric shock.
- Securely connect the cables in accordance with the connection examples. Failure to do so may result in fire or electric shock.
- Do not forcibly bend, pull or pinch the lead wire (cable). Doing so may result in fire and electric shock.
- Insulate the connection terminals of the supplied capacitor using the supplied capacitor cap. Failure to do so may result in electric shock.
- Turn off the power in the event of a power failure. Or the motor may suddenly start when the power is restored and may cause injury or damage to equipment.
- Do not touch the connection terminal of the capacitor immediately after the power is turned off (for a period of 30 seconds). The residual voltage may cause electric shock.
- Do not disassemble or modify the motor. This may cause electric shock or injury.



Handling the product without observing the instructions that accompany a "Caution" symbol may result in injury or property damage.

- Do not use the motor beyond its specifications. Doing so may result in electric shock, injury or damage to equipment.
- Do not touch the motor during operation or immediately after stopping. The surface is hot and may cause a skin burn(s).

Thank you for purchasing an Oriental Motor product.

This Operating Manual describes product handling procedures and safety precautions.

- Please read it thoroughly to ensure safe operation.
- Always keep the manual where it is readily available.

- Do not lift the motor by holding the motor output shaft or motor lead wires. Doing so may result in injury.
- Keep the area around the motor free of combustible materials. Failure to do so may result in fire or a skin burn(s).
- Do not leave anything around the motor that would obstruct ventilation. Doing so may result in damage to equipment.
- Do not touch the rotating part (output shaft) while operating the motor. Doing so may result in injury.
- When an abnormality is noted, turn off the power immediately. Failure to do so may result in fire, electrical shock or injury.
- The motor surface temperature may exceed 70 °C (158 °F) even under normal operating conditions. If the operator is allowed to approach the running motor, attach a warning label as shown in the figure in a conspicuous position. Failure to do so may result in a skin burn(s).
- To dispose of the motor, disassemble it into parts and components as much as possible and dispose of individual parts/components as industrial waste.



Warning label

### Preparation

#### ■ Checking the product

Verify that the items listed below are included. Report any missing or damaged items to the branch or sales office from which you purchased the product.

- Motor ..... 1 unit  
This product comes with the motor and its dedicated gearhead pre-assembled.
- Capacitor ..... 1 piece
- Capacitor cap ..... 1 piece
- Hexagonal socket head screw set..... 1 set  
Hexagonal socket head screw, washer, spring washer 4 pieces each, parallel key 1 piece
- OPERATING MANUAL ..... 1 copy (this document)

#### ■ Checking the model name

Check the model number against the number indicated on the product. Enter the gear ratio in the box (□) within the model name.

#### • Lead wire type

Model	Motor model	Gearhead model	Degree of protection
21K6UA-□□	21K6GV-UA	2GV□□	IP20
21K6UC-□□	21K6GV-UC		
31K15UA-□□	31K15GV-UA	3GV□□	
31K15UC-□□	31K15GV-UC		
41K25UA-□□	41K25GV-UA	4GV□□	
41K25UC-□□	41K25GV-UC		
51K40UA-□□	51K40GV-UA	5GV□□	
51K40UC-□□	51K40GV-UC		
51K60UA-□□	51K60GVH-UA	5GVH□□	
51K60UC-□□	51K60GVH-UC		
51K90UA-□□	51K90GVR-UA	5GVR□□	
51K90UC-□□	51K90GVR-UC		

#### • Terminal Box Type

Model	Motor model	Gearhead model	Degree of protection
41K25UAT2-□□	41K25GV-UAT2	4GV□□	IP66
41K25UCT2-□□	41K25GV-UCT2		
51K40UAT2-□□	51K40GV-UAT2	5GV□□	
51K40UCT2-□□	51K40GV-UCT2		
51K60UAT2-□□	51K60GVH-UAT2	5GVH□□	IP54
51K60UCT2-□□	51K60GVH-UCT2		
51K90UAT2-□□	51K90GVR-UAT2	5GVR□□	
51K90UCT2-□□	51K90GVR-UCT2		

## Installation

### ■ Location for installation

Install it in a well-ventilated location that provides easy access for inspection.

[ Common conditions ]

- Operating ambient temperature -10 to +40 °C (+14 to +104 °F) (non-freezing)
- Operating ambient humidity 85% or less (non-condensing)
- Area that is free from an explosive atmosphere or toxic gas (such as sulfuric gas) or liquid
- Area not exposed to direct sun
- Area free of excessive amount dust, iron particles or the like
- Area free of excessive salt
- Area not subject to continuous vibration or excessive shocks
- Area free of excessive electromagnetic noise (from welders, power machinery, etc.)
- Area free of radioactive materials, magnetic fields or vacuum
- Altitude Up to 1000 m (3300 ft.) above sea level

[ Degree of protection IP66 rated motor ]

- Indoors
  - Not exposed to oil (oil droplets) or chemicals.
- The motor can be used in an environment that is splashed with water.  
Not available for use under high pressure jets of water or immersion in water.

[ Degree of protection IP54/20 rated motor ]

- Inside an enclosure that is installed indoors (provide vent holes)
- Area not subject to splashing water (storms, water droplets), oil (oil droplets) or other liquids

### Note

On rare occasions, a small amount of grease may ooze out from the gearhead. If there is a concern over possible environmental damage resulting from the leakage of grease, provide an oil tray or similar oil catching mechanism in order not to cause a secondary damage. Oil leakage may lead to problems in the customer's equipment or products.

### ■ How to install the motor

Secure the motor with hexagonal socket head screws (supplied) through the four mounting holes provided. Do not leave a gap between the motor and mounting plate.

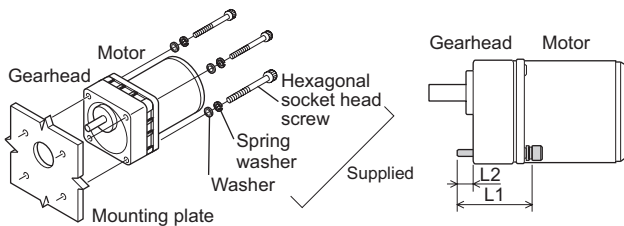

Hexagonal socket head screw set (supplied)

Model	Gear ratio	Hexagonal socket head screw Material: Stainless steel		Tightening torque	
		Screw size	L1 [mm (in.)]		L2 [mm (in.)]
2IK6	5 to 25	No.8-32UNC	50.8 (2)	8 (0.31)	1.4 N·m (12 lb-in)
	30 to 120		57.2 (2.25)	10 (0.39)	
	150 to 360		63.5 (2.5)	12 (0.47)	
3IK15	5 to 25	1/4-20UNC	57.2 (2.25)	9 (0.35)	5.0 N·m (44 lb-in)
	30 to 120		63.5 (2.5)	10 (0.39)	
	150 to 360		69.9 (2.75)	12 (0.47)	
4IK25	5 to 25	5/16-18UNC	63.5 (2.5)	12 (0.47)	12.0 N·m (106 lb-in)
	30 to 120		69.9 (2.75)	14 (0.55)	
	150 to 360		76.2 (3)	15 (0.59)	
5IK40 5IK60	5 to 18	5/16-18UNC	69.9 (2.75)	14 (0.55)	12.0 N·m (106 lb-in)
	25 to 100		82.6 (3.25)	13 (0.51)	
	120 to 300		88.9 (3.5)	14 (0.55)	
5IK90	5 to 15	5/16-18UNC	69.9 (2.75)	14 (0.55)	12.0 N·m (106 lb-in)
	18 to 36		82.6 (3.25)	13 (0.51)	
	50 to 180		95.3 (3.75)	14 (0.55)	

### ■ Removing/Installing the gearhead

See the following steps to replace the gearhead or to change the outlet position of the lead wires and the position of the terminal box.

#### ● Removing the gearhead from the motor

Remove the hexagonal socket head screws (2 pcs.) assembling the motor and gearhead and detach the motor from the gearhead.



Gearhead model	Screw size	Tightening torque
2GV□A 3GV□A 4GV□A	M2.6	0.4 N·m (3.5 lb-in)
5GV□A 5GVH□A 5GVR□A	M3	0.6 N·m (5.3 lb-in)

### ● Installing the gearhead to the motor

1. Using the pilot sections of the motor and gearhead as guides, install the gearhead to the motor.  
At this time, install the gearhead while slowly rotating it clockwise/counterclockwise so that the pinion of the motor output shaft does not hit the side panel or gears of the gearhead.
2. Check no gaps remain between the motor and gearhead, and tighten them with hexagonal socket head screws (2 parts).

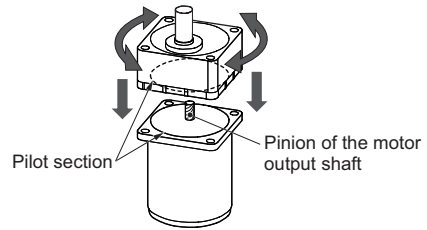

Assemble the gearhead to the motor in a condition where the motor output shaft is in an upward direction.

### Note

- Do not forcibly assemble the motor and gearhead. Also, do not let metal objects or other foreign matters enter the gearhead. The pinion or gear of the motor output shaft may be damaged, resulting in noise or shorter service life.
- Do not allow dust to attach to the pilot sections of the motor and gearhead. Also, assemble the motor and gearhead carefully by not pinching the O-ring at the motor pilot section. If the O-ring is crushed or severed, grease may leak from the gearhead.
- The hexagonal socket head screws assembling the motor and gearhead are used to attach the motor and gearhead temporarily. When installing the motor/gearhead assembly, be sure to use the supplied hexagonal socket head screws.

### ■ Motor with cooling fan

When installing a motor with cooling fan onto a device, leave 10 mm (0.39 in.) or more behind the fan cover or open a ventilation hole so that the cooling inlet on the back of the motor cover is not blocked.

### ■ Mounting the capacitor

Mount the capacitor securely by using No.8-32UNC or M4 screws (not provided).

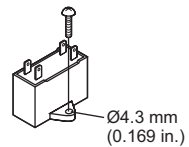

### Note

- Do not let the screw fastening torque exceed 1 N·m (8.8 lb-in) to prevent damage to the mounting foot.
- Mount capacitor at least 10 cm (3.94 in.) away from the motor. If it is located closer, the life of the capacitor will be shortened.

### ■ Installing a load

The gearhead shaft is provided with a key slot for connecting the transmission parts. When connecting the transmission parts, ensure that the shaft and parts have a clearance fit, and always fix the parallel key to the output shaft with a screw to prevent the parts from rattling or spinning.

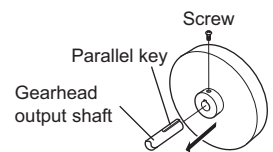

### Note

- Do not apply excessive force onto the output shaft of the gearhead using a hammer or other tools. Doing so may cause damage to the output shaft or bearings.

### ● When using the output shaft end tapped hole of a gearhead

Use a tapped hole provided at the end of the output shaft as an auxiliary means for preventing the transfer mechanism from disengaging. (2GV□A, 3GV□A type have no output shaft end tapped hole.)

Gearhead model	Output shaft end tapped hole
4GV□A	No.10-24 UNC, Effective depth 10 mm (0.39 in.)
5GV□A 5GVH□A 5GVR□A	No.12-24 UNC, Effective depth 12 mm (0.47 in.)

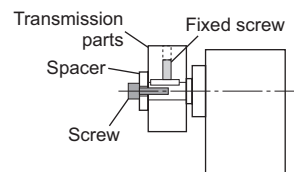

## Connection and operation

- Insulate all the wire connections, such as the connection between the motor and the capacitor connection.
- Ground the motor using a Protective Earth Terminal.

- Note**
- Make sure that the motor case temperature does not exceed 90 °C (194 °F) when operating the motor. Operation exceeding case temperature 90 °C (194 °F) may significantly deteriorate the coils and ball bearings of the motor and shorten the motor's life span. Motor case temperature can be measured by fixing a thermometer on the motor surface. It can also be measured using thermo tape or a thermocouple.
  - To change rotation direction of the motor, wait until the motor completely stops. Otherwise its direction may not change or may take much time to change.

### Wiring diagram

Check the output power and gear ratio of the motor before connecting.

Wiring diagram No.

Motor model	Gear ratio	Wiring diagram	Gear ratio	Wiring diagram
2IK6 3IK15 4IK25	5 to 25, 150 to 360	Lead wire type: ①	30 to 120	Lead wire type: ②
5IK40 5IK60	5 to 18, 120 to 300	Terminal box type: ③	25 to 100	Terminal box type: ④
5IK90	5 to 15, 75 to 180	③	18 to 60	④

Wiring diagram

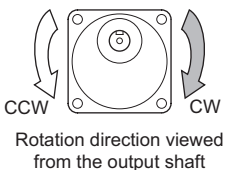
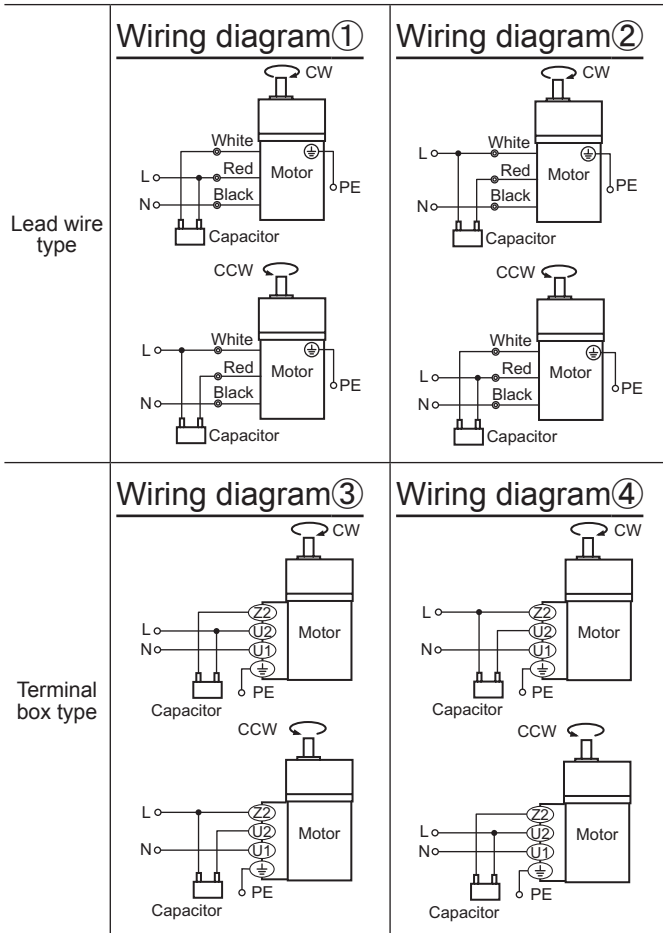

The direction of rotation is as viewed from the side of the output shaft. The rotation in the clockwise direction represents "CW" and the rotation in the counterclockwise direction represents "CCW." The rotation direction of the output shaft varies depending on the gear ratio of the gearhead.

### Capacitor connection

The capacitor internal wiring as follows: Capacitor terminals are internally electrically connected in two; A-B and C-D for easy connection.

For easy to install terminals use 187 series FASTON terminals (TE Connectivity). Use the supplied capacitor cap to insulate the capacitor terminal connection.

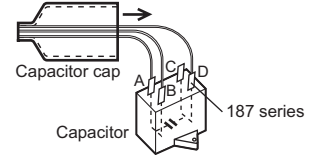

- Note** For lead wire connection, use one lead wire for each individual terminal.

### Lead wire type

#### Connecting Protective Earth Terminal

Ground the motor using the Protective Earth Terminal ⊕ on the motor.

Applicable crimp terminal:  
Insulated round crimp terminal  
Terminal screw size: M4

Tightening torque:  
1.0 to 1.3 N·m (8.8 to 11.5 lb-in)  
Applicable minimum lead wire size:  
AWG18 (0.75 mm<sup>2</sup>) or thicker

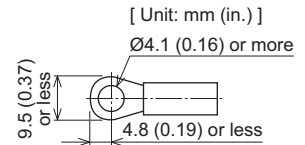

- Note** Do not use screws other than the Protective Earth Terminal screw attached on the product.

### Terminal Box Type

#### Connection method to a terminal box

##### Connection procedure

1. Loosen the terminal cover mounting screws, and remove the terminal cover from the terminal box.
2. Insert the cable through the cable gland, and connect the lead wires to the terminal block.  
Connect the grounding lead wire to the Protective Earth Terminal.
3. Install the terminal cover on the terminal box.

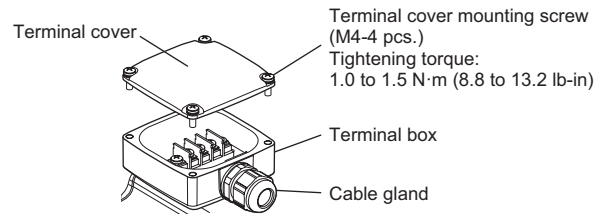

#### Insert the cable through the cable gland.

When inserting the cable through the cable gland, loosen the tightening nut. After connecting to the terminal block, turn the tightening nut to secure the cable.

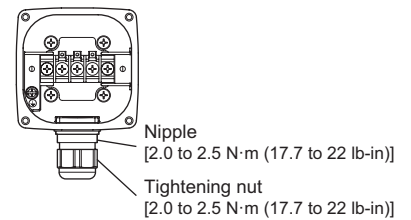

[ ] indicates the value of the tightening torque.

#### Connection method to a terminal block

- When connecting to the terminal block, use the following crimp terminal.

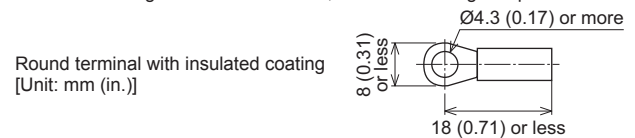

- To ensure safety, ground the motor using the Protective Earth Terminal ⊕ inside the terminal box.
- Layout of terminals  
Z2, U2 and U1 are indicated on the side face of the terminal block.

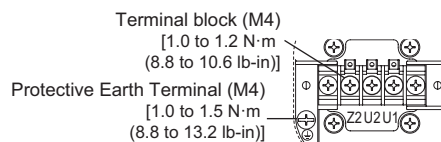

[ ] indicates the value of the tightening torque.

- Use a cable of the following specifications.  
Applicable cable diameter:  $\varnothing 7$  to  $\varnothing 13$  mm ( $\varnothing 0.28$  to  $\varnothing 0.51$  in.)  
Applicable lead wire: AWG18 (0.75 mm<sup>2</sup>) or thicker  
Connection cables are available as accessories. Refer to the product catalog for details.
- Although the O-ring that is set to the matching surface of the terminal cover is a structure not to fall off easily, install it in the groove portion of the terminal cover securely if it fell off.

**Note**

- To make shielding function fully effective, use a cable of an appropriate diameter and observe the specified tightening torque of screws.
- Secure the cable drawn from the motor terminal box so that it does not receive stress.

### ● Changing the cable outlet position

The cable outlet position can be changed to the left or right 90-degree direction, or the 180-degree direction by changing the mounting direction of the terminal box.

When changing the mounting direction of the terminal box, specify the cable outlet position based on the equipment to be installed.

#### Change procedure

1. Loosen the terminal cover mounting screws, and remove the terminal cover from the terminal box.
2. Loosen the terminal box mounting screws, and remove the terminal box from the motor case.

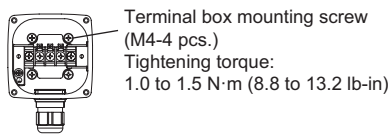

3. Change the cable outlet position of the terminal box from the mounting position at the time of shipment by turning the terminal box itself to the left or right 90-degree direction, or the 180-degree direction.

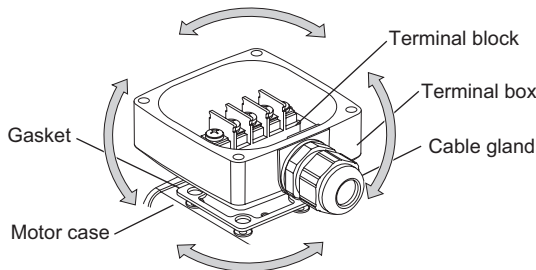

**Note**

- Be sure to use the gasket which has been put in the product at the time of shipment.
- Assemble not to enter any foreign object between the terminal box and motor case.

### Time rating

Continuous operation is possible (continuous rating).

### Locked rotor burnout protection

This motor is equipped with one of the two features listed below to prevent the motor from burning out as a result of abnormal heating which may be caused by misapplication.

#### ■ Thermal protection

"TP" is stamped on the motor nameplate. The motor has an "auto reset" type thermal protector built into its motor coil. When the motor reaches a predetermined temperature, the internal thermal protector is activated and the motor is stopped.

Always turn the power off before performing inspections.

Thermal protector activation range:

Power is turned off at  $130 \pm 5$  °C ( $266 \pm 9$  °F)

Power is turned back on at  $85 \pm 20$  °C ( $185 \pm 36$  °F)

#### ■ Impedance protection

"ZP" is stamped on the motor nameplate. The motor has higher coil impedance. When the motor goes into locked rotor condition due to a malfunction, coil impedance rises, suppressing input power to the motor and protecting the motor coil from burnout.

### Troubleshooting

When the motor cannot be operated correctly, refer to the contents provided in this section and take appropriate action. If the problem persists, contact your nearest office.

Phenomena	Check items
Motor does not rotate.	<ul style="list-style-type: none"> <li>• Check the power supply voltage.</li> <li>• Connect the power supply and the motor correctly.</li> <li>• Connect the supplied capacitor correctly.</li> </ul>
Motor sometimes rotates and stops.	<ul style="list-style-type: none"> <li>• If terminal blocks or crimp terminals are used, check them for poor connection.</li> <li>• Keep the load at or below the allowable value.</li> </ul>

Phenomena	Check items
The motor rotates in the direction opposite to the specified direction.	<ul style="list-style-type: none"> <li>• Connect the supplied capacitor correctly.</li> <li>• The connection varies depending on the gear ratio of the gearhead.</li> <li>• The rotation direction is as viewed from the output shaft end. Check the reference direction.</li> </ul>
Motor temperature abnormally high [Motor case temperature exceeds 90 °C (194 °F)]	<ul style="list-style-type: none"> <li>• Check the power supply voltage.</li> <li>• With a single-phase motor, connect the supplied capacitor correctly.</li> <li>• Review the ventilation condition.</li> </ul>
Noisy operation	<ul style="list-style-type: none"> <li>• Assemble the motor and gearhead correctly.</li> <li>• Assemble a gearhead of the same pinion types as the motor.</li> </ul>

### Standard and CE Marking

- This product is recognized by UL under the UL and CSA standards. Also, it conforms to the China Compulsory Certification System (CCC System). The motor model name is the recognized product name.
- The motor is affixed the CE Marking under the Low Voltage Directive.

#### ■ UL Standards, CSA Standards, CCC System

Applicable standards	Certification Body / File No.
UL 1004-1, UL 1004-2, UL 1004-3	UL /
CSA C22.2 No.100, CSA C22.2 No.77	UL File No.E64197, E64199
GB 12350	CQC

- Thermal Class: 130 (B)

#### ■ Low Voltage Directive

- Applicable standards  
EN 60034-1, EN 60034-5, EN 60664-1

Momentary excess torque based on EN 60034-1

Model	Momentary excess torque	Momentary excess torque represents a maximum torque that can maintain the operation for 15 seconds without stalling or abrupt speed change even if the torque is increased gently while operating at rated voltage and rated frequency.
2IK6, 3IK15	120% of the rated torque	
4IK25, 5IK40, 5IK60	130% of the rated torque	
5IK90	140% of the rated torque	

- Installation conditions (For EN standard)

Lead wire type: Overvoltage category II, Pollution degree 2, Class I equipment

Terminal box type: Overvoltage category II, Pollution degree 3, Class I equipment

When the machinery to which the motor is mounted requires overvoltage category III specifications, install the motor in a cabinet that connect to power supply via an isolation transformer.

#### ■ Motor temperature rise tests

Temperature rise tests required by the above standards are performed in a state that has been attached a heat radiation plate instead of a gearhead. The size and material for the heat radiation plates are as follows.

2IK6: 115×115 mm (4.53×4.53 in.)      3IK15: 125×125 mm (4.92×4.92 in.)

4IK25: 135×135 mm (5.31×5.31 in.)      5IK40: 165×165 mm (6.50×6.50 in.)

5IK60, 5IK90: 200×200 mm (7.87×7.87 in.)

Thickness: 5 mm (0.20 in.)      Material: Aluminum alloy

#### ■ Standards for accessories

- Capacitor: UL File No.E83671 (CYWT2),  
VDE License Nos.112847 (capacitors with a rated voltage of 250 VAC),  
114747 (capacitors with a rated voltage of 450 VAC)
- Capacitor cap: UL File No.E56078 (YDTU2)

- Unauthorized reproduction or copying of all or part of this manual is prohibited.
- Oriental Motor shall not be liable whatsoever for any problems relating to industrial property rights arising from use of any information, circuit, equipment or device provided or referenced in this manual.
- Characteristics, specifications and dimensions are subject to change without notice.
- **Oriental motor** is a registered trademark or trademark of Oriental Motor Co., Ltd., in Japan and other countries.

© Copyright ORIENTAL MOTOR CO., LTD. 2016

- Please contact your nearest Oriental Motor office for further information.

ORIENTAL MOTOR U.S.A. CORP.  
Technical Support Tel:(800)468-3982  
8:30 A.M. to 5:00 P.M., P.S.T. (M-F)  
7:30 A.M. to 5:00 P.M., C.S.T. (M-F)  
www.orientalmotor.com  
ORIENTAL MOTOR DO BRASIL LTDA.  
Tel:+55-11-3266-6018  
www.orientalmotor.com.br  
ORIENTAL MOTOR (EUROPA) GmbH  
Schiessstraße 74, 40549 Düsseldorf, Germany  
Technical Support Tel:00 800/22 55 66 22  
www.orientalmotor.de  
ORIENTAL MOTOR (UK) LTD.  
Tel:01256-347090  
www.oriental-motor.co.uk  
ORIENTAL MOTOR (FRANCE) SARL  
Tel:01 47 86 97 50  
www.orientalmotor.fr  
ORIENTAL MOTOR ITALIA S.r.l.  
Tel:02-93906346  
www.orientalmotor.it  
ORIENTAL MOTOR CO., LTD.  
4-8-1 Higashi-ueno, Taito-ku, Tokyo 110-8536  
Japan  
Tel:03-6744-0361  
www.orientalmotor.co.jp

ORIENTAL MOTOR ASIA PACIFIC PTE. LTD.  
Singapore  
Tel:1800-8420280  
www.orientalmotor.com.sg  
ORIENTAL MOTOR (MALAYSIA) SDN. BHD.  
Tel:1800-806161  
www.orientalmotor.com.my  
ORIENTAL MOTOR (THAILAND) CO., LTD.  
Tel:1800-888-881  
www.orientalmotor.co.th  
ORIENTAL MOTOR (INDIA) PVT. LTD.  
Tel:+91-80-41125586  
www.orientalmotor.co.in  
TAIWAN ORIENTAL MOTOR CO., LTD.  
Tel:0800-060708  
www.orientalmotor.com.tw  
SHANGHAI ORIENTAL MOTOR CO., LTD.  
Tel:400-820-6516  
www.orientalmotor.com.cn  
INA ORIENTAL MOTOR CO., LTD.  
Korea  
Tel:080-777-2042  
www.inaom.co.kr  
ORIENTAL MOTOR CO., LTD.  
Hong Kong Branch  
Tel:+852-2427-9800