

OPERATING MANUAL

BH Series

Induction Motors



Introduction

■ Before using the motor

Only qualified personnel of electrical and mechanical engineering should work with the product. Use the product correctly after thoroughly reading the section "Safety precautions." In addition, be sure to observe the contents described in warning, caution, and note in this manual. The product described in this document has been designed and manufactured to be incorporated in general industrial equipment. Do not use for any other purpose. Oriental Motor Co., Ltd. is not responsible for any damage caused through failure to observe this warning.

Safety precautions

The precautions described below are intended to ensure the safe and correct use of the product, and to prevent the customer and others from exposure to the risk of injury. Use the product only after carefully reading and fully understanding these instructions.

	WARNING	Handling the product without observing the instructions that accompany a "WARNING" symbol may result in serious injury or death.
	CAUTION	Handling the product without observing the instructions that accompany a "CAUTION" symbol may result in injury or property damage.
	Note	The items under this heading contain important handling instructions that the user should observe to ensure safe use of the product.

[Description of graphic symbols]

- : Indicates "prohibited" actions that must not be performed.
- : Indicates "compulsory" actions that must be performed.

⚠ WARNING

	<ul style="list-style-type: none"> • Do not use the product in explosive or corrosive environments, in the presence of flammable gases, locations subjected to splashing water, or near combustibles. Doing so may result in fire, electric shock or injury. • Do not move, install, connect or inspect the product while the power is supplied. Always turn off the power before carrying out these operations. Failure to do so may result in electric shock. • Do not forcibly bend, pull or pinch the lead cable (wire). Doing so may result in fire and electric shock. • Do not touch the connection terminal of the capacitor immediately after the power is turned off (for a period of 30 seconds). The residual voltage may cause electric shock. • Do not disassemble or modify the motor and gearhead. This may cause electric shock, injury or damage to equipment.
	<ul style="list-style-type: none"> • Only qualified and educated personnel should be allowed to perform installation, connection, operation and inspection/troubleshooting of the product. Handling by unqualified and uneducated personnel may result in fire, electric shock or injury. • Turn off the power in the event the overheat protection device (thermal protector) is triggered. Failure to do so may result in injury or damage to equipment, since the motor will start abruptly when the overheat protection device (thermal protector) is automatically reset. • The motor is Class I equipment. Install the motor so as to avoid contact with hands, or ground it to prevent the risk of electric shock. • Install the motor in an enclosure. Failure to do so may result in electric shock or injury. • Keep the input power voltage within the specified range. Failure to do so may result in fire or electric shock. • Securely connect the cables in accordance with the connection diagram. Failure to do so may result in fire or electric shock. • Insulate the connection terminals of the supplied capacitor using the supplied capacitor cap. Failure to do so may result in electric shock. • Turn off the power in the event of a power failure. Or the motor may suddenly start when the power is restored and may cause injury or damage to equipment.

Thank you for purchasing an Oriental Motor product. This Operating Manual describes product handling procedures and safety precautions.

- Please read it thoroughly to ensure safe operation.
- Always keep the manual where it is readily available.

⚠ CAUTION

	<ul style="list-style-type: none"> • Do not use the motor, gearhead beyond its specifications. Doing so may result in electric shock, injury or damage to equipment. • Do not touch the motor, gearhead during operation or immediately after stopping. The surface is hot and may cause a skin burn(s). • Do not lift the motor by holding the motor output shaft or motor lead wires (cables). Doing so may result in injury. • Do not touch the motor output shaft (end or pinion) with bare hands. Doing so may cause injury. • Keep the area around the motor free of combustible materials. Failure to do so may result in fire or a skin burn(s). • Do not leave anything around the motor that would obstruct ventilation. Doing so may result in damage to equipment. • Do not touch the rotating part (output shaft) while operating the motor. Doing so may result in injury.
	<ul style="list-style-type: none"> • When installing the motor, gearhead in the equipment, exercise caution not to pinch your fingers or other parts of your body between the equipment and motor or gearhead. Injury may result. • Provide a cover on the rotating part (output shaft). Failure to do so may result in injury. • Securely install the load on the output shaft. Inappropriate installation may result in injury. • When an abnormality is noted, turn off the power immediately. Failure to do so may result in fire, electric shock or injury. • The motor surface temperature may exceed 70 °C (158 °F) even under normal operating conditions. If the operator is allowed to approach the running motor, attach a warning label as shown in the figure in a conspicuous position. Failure to do so may result in a skin burn(s). • Dispose the product correctly in accordance with laws and regulations, or instructions of local governments.



Warning label

Preparation

■ Checking the product

Verify that the items listed below are included. Report any missing or damaged items to the branch or sales office from which you purchased the product.

- Motor..... 1 unit
The combination type comes with the motor and its dedicated gearhead pre-assembled.
- Capacitor 1 piece (for only single-phase motors)
- Capacitor cap..... 1 piece (for only single-phase motors)
- Parallel key..... 1 piece (only for combination type)
For BH6G2-□, BH8G-□ and BH6G2-□RA, the parallel key is fixed to the gearhead output shaft.
- Mounting screw..... 1 set (only for combination type parallel shaft)
Hexagonal socket head screw, hexagonal nuts, washer, spring washer: 4 pieces each
- OPERATING MANUAL..... 1 copy (this document)

■ Checking the model name

This operation manual covers the following products. Make sure that the product is the one you ordered and is listed below by checking the model number listed on the nameplate. Verify that the voltage and output listed on the nameplate are appropriate for your application and that the correct value capacitor has been provided.

Enter the number representing the gear ratio of the gearhead in the box □ within the model name.

● Combination type

Model	Motor model	Gearhead model	
BHI62A-□*	BHI62A-G2	BH6G2-□ BH6G2-□RA BH6G2-□RH	
BHI62AT-□*	BHI62AT-G2		
BHI62C-□*	BHI62C-G2		
BHI62CT-□*	BHI62CT-G2		
BHI62E-□*	BHI62E-G2		
BHI62ET-□*	BHI62ET-G2		
BHI62F-□*	BHI62F-G2		
BHI62FT-□*	BHI62FT-G2		
BHI62S-□*	BHI62S-G2		
BHI62ST-□*	BHI62ST-G2		
BHI62U-□*	BHI62U-G2		
BHI62UT2-□*	BHI62UT2-G2		
BHI82A-□	BHI82A-G		BH8G-□
BHI82AT-□	BHI82AT-G		
BHI82C-□	BHI82C-G		
BHI82CT-□	BHI82CT-G		
BHI82E-□	BHI82E-G		
BHI82ET-□	BHI82ET-G		
BHI82F-□	BHI82F-G		
BHI82FT-□	BHI82FT-G		
BHI82ST-□	BHI82ST-G		

* For right-angle shaft gearhead, there is **RA** or **RH** in the end of the model number.

● Round shaft type

Model (Motor model)
BHI62A-A
BHI62AT-A
BHI62C-A
BHI62CT-A
BHI62E-A
BHI62ET-A
BHI62F-A
BHI62FT-A
BHI62S-A
BHI62ST-A
BHI62U-A
BHI62UT2-A

■ Installation method



Do not install the motor to the mounting hole diagonally or assemble the motor forcibly. Doing so may cause damage to the motor.

● Combination type: parallel shaft gearhead

Secure the motor with mounting screw set (supplied) through the four mounting holes provided. (Mounting plate thickness is 10 mm (0.39 in.) when using the supplied mounting screws.)

Do not leave a gap between the motor and mounting plate.

Model	Screw size	Tightening torque
BHI62	M8	15.5 N·m (137 lb-in)
BHI82	M10	25 N·m (220 lb-in)

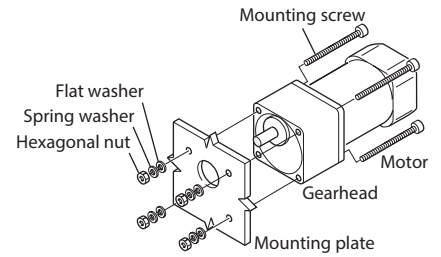

● Combination type: right-angle shaft gearhead

Secure the motor with screws (not supplied) through the four mounting holes provided. Do not leave a gap between the motor and mounting plate.

Model	Screw size	Tightening torque
BHI62	M8	15.5 N·m (137 lb-in)

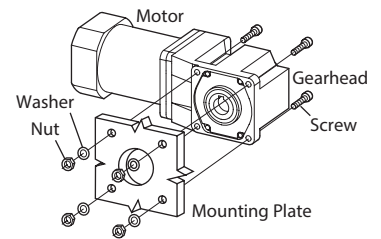

- For BH6G2-□RH, when the motor is installed to equipment using the gearhead flange surface, proper alignment between the hollow shaft inside dimension and the load shaft is necessary. Insufficient alignment may result in damage to the gearhead internal bearings.
- The diameter of the boss of the shaft is Ø58h8, use it as a guide for proper alignment.

Installation

■ Location for installation

Install the motor and capacitor in a location that meets the following conditions. Using the motor and capacitor in a location that does not satisfy these conditions could damage them.

- Indoors
- Ambient temperature: -10 °C to +40 °C [+14 °F to +104 °F] (non-freezing)
(-10 °C to +50 °C [+14 °F to +122 °F] for 100/200 VAC) (non-freezing)
- Ambient humidity: 85% or less (non-condensing)
- Not exposed to explosive, flammable, or corrosive gases
- Not exposed to direct sunlight
- Not exposed to dust
- Not exposed to water or oil
- A place where heat can escape easily
- Not exposed to continuous vibration or excessive impact
- 1,000 meters or less above sea level



On rare occasions, grease may ooze out from the gearhead. If there is a concern over possible environmental damage resulting from the leakage of grease, provide an oil tray or similar oil catching mechanism in order not to cause a secondary damage. Grease leakage may lead to problems in the customer's equipment or products.

Removing and assembling the gearhead

See the following steps to replace the gearhead or to change the outlet position of the lead wires and the position of the terminal box.

Removing the gearhead from the motor

Remove the hexagonal socket head screws (2 places or 4 places) assembling the motor and gearhead and detach the motor from the gearhead.

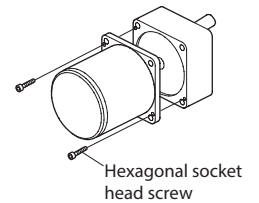

Assembling the gearhead to the motor

- Keep the pilot sections of the motor and gearhead in parallel, and assemble the gearhead with the motor while slowly rotating it clockwise/counterclockwise. At this time, note so that the pinion of the motor output shaft does not hit the side panel or gears of the gearhead strongly.
- Check that there is no gap between the motor and gearhead, and tighten them with hexagonal socket head screws (2 pieces or 4 pieces).

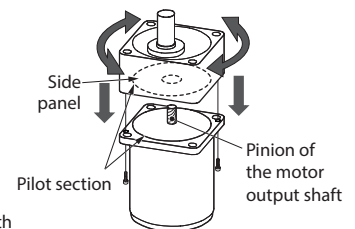

Assemble the gearhead to the motor in a condition where the motor output shaft is in an upward direction.

Gearhead model	Screw size	Tightening torque
BH6G2-□, BH8G-□	M4	1.8 N·m (15.9 lb-in)
BH6G2-□RH, BH6G2-□RA	M8	15.5 N·m (137 lb-in)



- Do not forcibly assemble the motor and gearhead. Also, prevent metal objects or foreign substances from entering in the gearhead. The pinion of the motor output shaft or gear may be damaged, resulting in noise or shorter service life.
- Do not allow dust to attach to the pilot sections of the motor and gearhead. Also, assemble the motor and gearhead carefully by not pinching the O-ring at the motor pilot section. If the O-ring is crushed or severed, grease may leak from the gearhead.

● **Round shaft type**

Secure the motor with hexagonal socket head screws (not supplied) through the four mounting holes provided. Do not leave a gap between the motor and mounting plate.

Model	Screw size	Tightening torque
BH162	M8	15.5 N·m (137 lb·in)

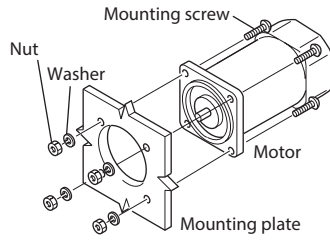

● **Motor with cooling fan**

When installing a motor with cooling fan onto a device, leave 10 mm (0.39 in.) or more behind the fan cover or open a ventilation hole so that the cooling inlet on the back of the motor cover is not blocked.

■ **Mounting the capacitor (only for single-phase motors)**

Before mounting the provided capacitor, check that the capacitor's capacitance matches that stated on the motor's nameplate.

Mount the capacitor securely by using M4 screws (not provided).

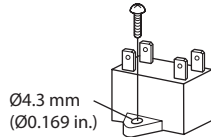

- Note**
- Do not let the screw fastening torque exceed 1 N·m (8.8 lb·in) to prevent damage to the mounting foot.
 - Mount capacitor at least 10 cm (3.94 in.) away from the motor. If it is located closer, the life of the capacitor will be shortened.

■ **Installing a load**

- Note** When the hollow-shaft gearhead or solid-shaft gearhead with a low gear ratio (5, 6, 7.5 or 9) is combined with a single-phase motor, noise (resonance sound) may occur during operation under no or light load. This noise can be reduced by adding a frictional load.

● **Combination type: parallel shaft gearhead, Combination type: right-angle shaft (solid shaft) gearhead**

The gearhead shaft is provided with a key slot for connecting the transmission parts. When connecting the transmission parts, ensure that the shaft and parts have a clearance fit, and always fix the parallel key to the output shaft with a screw to prevent the parts from rattling or spinning.

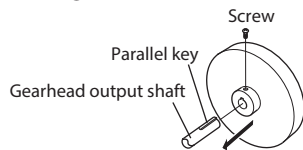

- Note** Do not apply excessive force onto the output shaft of the gearhead using a hammer or other tools. Doing so may cause damage to the output shaft or bearings.

● **When using the output shaft end tapped hole of a gearhead**

Use a tapped hole [M6, Effective depth 12 mm (0.47 in.)] provided at the end of the output shaft of BH6G2-□ and BH6G2-□RA as an auxiliary means for preventing the transfer mechanism from disengaging.

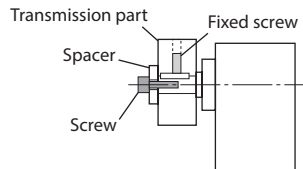

● **Combination type: right-angle shaft (hollow shaft) gearhead**

Mounting method of the load varies depending on the load shaft conditions. See the following figures.

The hollow output shaft inside dimension is processed to a tolerance of H8, and incorporates a key slot for load shaft attachment. A load shaft tolerance of h7 is recommended. Also, apply anti-seizing agent such as molybdenum disulfide grease on the surface of the load shaft and the bore of the hollow output shaft. After attaching the load, attach the safety cover.

● **Recommended load shaft dimensions** [Unit: mm (in.)]

Gearhead model	Hollow shaft Inside dimensions (H8)	Recommended load shaft dimensions (h7)
BH6G2-□RH	$\varnothing 25^{+0.033}_{0}$ ($\varnothing 0.9843^{+0.0013}$)	$\varnothing 25^{0}_{-0.021}$ ($\varnothing 0.9843_{-0.0008}$)

● **Stepped load shaft**

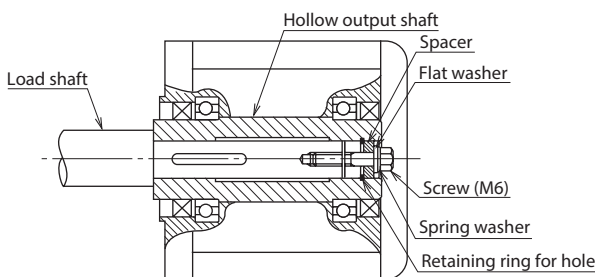

● **Non-stepped load shaft**

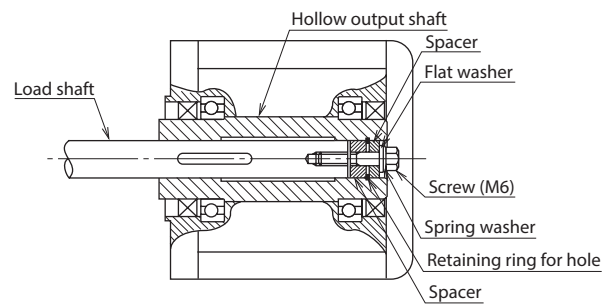

- Note** Do not apply excessive force when inserting the load shaft into the gearhead. Excessive or abrupt force may damage the gearhead internal bearings.

Connection

Insulate all the wire connections such as the connecting part between the motor lead wires and the power supply. Be sure to ground the product using the Protective Earth Terminal on the motor.

■ **Connection method to a terminal box**

- Note**
- To make shielding function fully effective, use a cable of an appropriate diameter.
 - Securely affix the cable exposed outside the motor so that it does not receive stress.

● **Single-phase motors, three-phase 200 VAC/220 VAC/230 VAC motors**

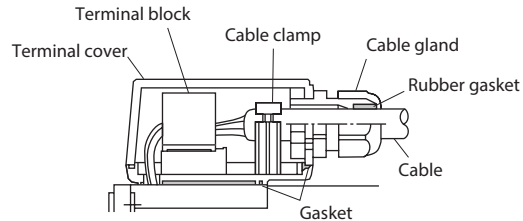
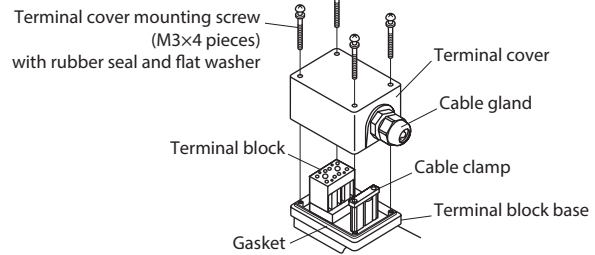

- To ensure safety, ground the motor using the Protective Earth Terminal (⊕) inside the terminal box. On the BH162ST-A, refer to the following specifications. [Unit: mm (in.)]
 Applicable crimp terminal: Insulated round crimp terminal
 Terminal screw size: M4
 Tightening torque: 1.0 to 1.3 N·m (8.8 to 11.5 lb·in)
 Applicable lead wire: AWG18 (0.75 mm²) or thicker

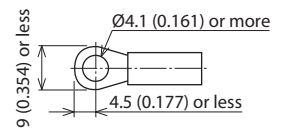

- For wiring, be sure to use cable (not provided) that meets the following specifications.
 Applicable cable diameter: Ø6 to Ø12 mm (Ø0.236 to Ø0.472 in.)
 Applicable lead wire: AWG24 to 12 (0.2 to 3.5 mm²)
 Length of strip is 8 mm (0.31 in.)

- When sealing the terminal box cover, ensure that no scraps or particles get caught between the contact surfaces.
- The terminal cover mounting screws are specifically designed for mounting the terminal cover. They are provided with a rubber seal and flat washer that keep the terminal box dust-resistant and splashproof. In order to maintain a tight seal around the terminal box, use only the provided screws. Also, this terminal box is constructed to hold a gasket. If this gasket comes out of the box, please reseal it correctly on the box. Also refer to the tightening torque table (below) to determine the appropriate tightening torque to use when fastening the terminal cover and cable gland.

Terminal cover	0.3 to 0.4 N·m (42 to 56 oz·in)
Cable gland	2.5 to 3.8 N·m (350 to 530 oz·in)
Cable clamp	0.2 to 0.3 N·m (28 to 42 oz·in)
Terminal block	0.5 to 0.8 N·m (71 to 113 oz·in)

● Three-phase 380 VAC/400 VAC/415 VAC motors

Connect the motor to a terminal box by following the procedure below:

1. Loosen the terminal cover mounting screws (M4×3 pieces) and remove the terminal cover and sheet gasket from the terminal box.
2. Pass the cable through the cable gland and connect the lead wires to the terminal block. Connect the lead wire for grounding to the Protective Earth Terminal.
3. Install the sheet gasket and terminal cover on the terminal box.

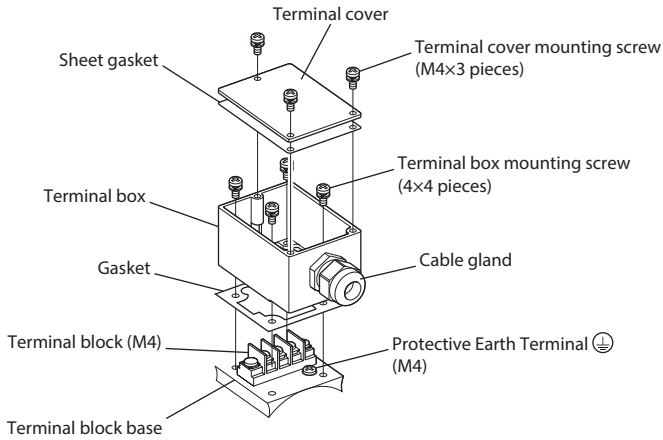

The terminal box can be removed. Loosen the terminal box mounting screws (M4×4 pieces) and take out the terminal box.

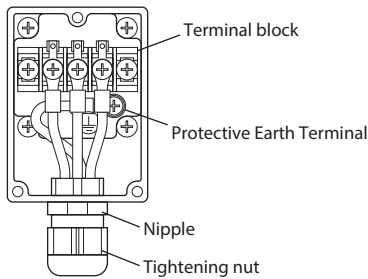

- To ensure safety, ground the motor using the Protective Earth Terminal (M4) inside the terminal box.
- Use a cable (not supplied) of the following specifications:
Applicable cable diameter: $\varnothing 6$ to $\varnothing 12$ mm ($\varnothing 0.236$ to 0.472 in.)
Applicable lead wire: AWG20 (0.5 mm²) or thicker
- When connecting the cable on the terminal block, use the following crimp terminal.

[Unit: mm (in.)]

Insulated round crimp terminal

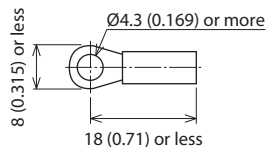

- Don't forget to assemble the sheet gasket between terminal box and terminal cover. When assembling the parts, also be careful not to let any foreign object enter between the terminal cover and terminal box.
- Refer to the table below to determine the appropriate tightening torque to use when fastening the terminal cover and cable gland.

Terminal cover	0.3 to 1.0 N·m (42 to 142 oz-in)
Terminal box	1.0 to 1.5 N·m (142 to 210 oz-in)
Cable gland (Tightening nut)	2.0 to 2.5 N·m (280 to 350 oz-in)
Cable gland (Nipple)	2.0 to 3.75 N·m (280 to 530 oz-in)
Terminal block	1.0 to 1.2 N·m (142 to 170 oz-in)
Protective Earth Terminal	1.0 to 1.5 N·m (142 to 210 oz-in)

Changing the cable outlet position

The cable outlet can be oriented and fixed in three different directions by changing the mounting direction of the terminal box. Follow the procedure below:

1. Loosen the terminal cover mounting screws (M4×3 pieces) and remove the terminal cover and sheet gasket from the terminal box.
2. Loosen the terminal box mounting screws (M4×4 pieces) and remove the terminal box from the terminal block base.
3. Turn the cable outlet on the terminal box clockwise or counterclockwise by 90° at a time from the factory-set position.
4. Install the terminal box onto the terminal block base.
5. Install the sheet gasket and terminal cover onto the terminal box.

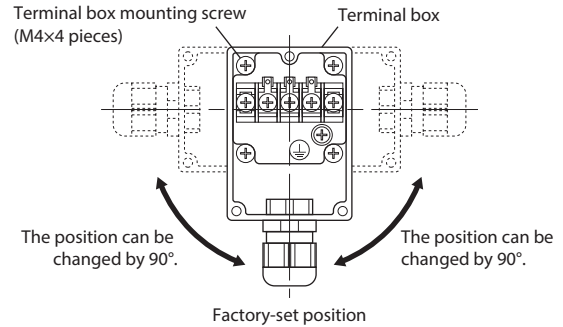

- A gasket is installed between the terminal box and terminal block base. Don't forget to assemble the gasket. When assembling the parts, also be careful not to let any foreign object enter between the terminal box and terminal block base.

- Refer to the aforementioned table for the screw tightening torque.

● Layout of terminals

Single-phase type

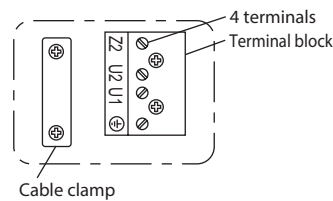

Three-phase type

● 200 VAC/220 VAC/230 VAC motors

[Combination type]

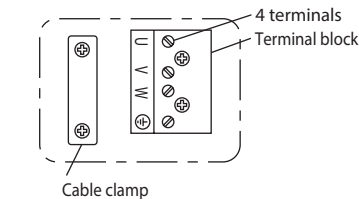

[Round shaft type]

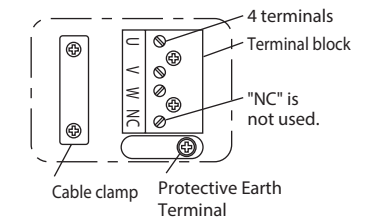

● 380 VAC/400 VAC/415 VAC motors

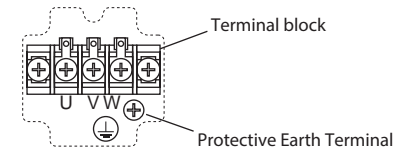

■ Connecting Protective Earth Terminal (cable type)

Ground the motor using the motor's Protective Earth Terminal (M4).

Applicable crimp terminal:

Insulated round crimp terminal

Terminal screw size: M4

Tightening torque: 1.0 to 1.3 N·m (8.8 to 11.5 lb-in)

Applicable lead wire: AWG18 (0.75 mm²) or thicker

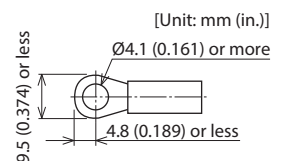

Note Be sure to use the screw for grounding attached on the product.

■ Connection diagram

The direction of rotation is as viewed from the side of the motor's output shaft. "CW" indicates clockwise and "CCW" counterclockwise. The gearhead's output shaft may, depending on the gear ratio, turn in the opposite direction of the motor shaft. Check the rotation direction before connecting.

● Single-phase motor

Model *1	Connection diagram *2
BHI62□■-3 to 9 BHI62□■-50 to 180 BHI82□■-60 to 180 BHI62□■-A	<p>Clockwise</p>
	<p>Counterclockwise</p>
BHI62□■-12.5 to 36 BHI82□■-30 to 50 BHI62□■-5 to 180RA BHI62□■-5 to 180RH	<p>Clockwise</p>
	<p>Counterclockwise</p>

*1 **A, C, E, F** appear at the position in the model number indicated by the box (□).

Enter **T** (terminal box) in the box (■) within the model name.

*2 Colors shown in the connection diagram indicate the colors of lead wires and Z2, U2, and U1 indicate terminal codes inside the terminal box.

● Capacitor connection (only for single-phase motors)

When crimp terminals are used, use the FASTON terminals 187 Series (TE Connectivity).

Use the supplied capacitor cap to insulate the capacitor terminal connection.

The capacitor has four terminals that are internally connected as shown in the figure.

<Capacitor internal wiring diagram>

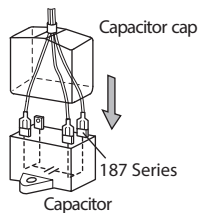
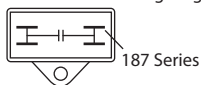

Note For lead wire connection, use one lead wire for each individual terminal.

● Three-phase motor

Model *1	Connection diagram *2
BHI62□■-3 to 9 BHI62□■-50 to 180 BHI82ST-60 to 180 BHI62□■-A	<p>Clockwise</p>
	<p>Counterclockwise</p> <p>To change the direction of rotation, change any two connections between R, S and T.</p>
BHI62□■-12.5 to 36 BHI82ST-30 to 50 BHI62□■-5 to 180RA BHI62□■-5 to 180RH	<p>Clockwise</p>
	<p>Counterclockwise</p> <p>To change the direction of rotation, change any two connections between R, S and T.</p>

*1 **S, U** appear at the position in the model number indicated by the box (□).

Enter **T** or **T2** (terminal box) in the box (■) within the model name.

*2 Colors shown in the connection diagram indicate the colors of lead wires and U, V, and W indicate terminal codes inside the terminal box.

● For protection of contact (switch)

If the switch is used for starting/stopping the motor or switching the rotation direction, connect the CR circuit for surge suppression in order to protect the contacts.

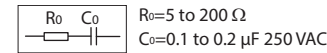

It is provided as a peripheral equipment (sold separately). Model: **EPCR1201-2**

Operation

The motor rotates when the power supply is turned on.

For protection against electric shock, do not turn on the power supply until the wiring is complete.

Note

- Make sure that the motor case temperature does not exceed 90°C (194°F) during motor operation. Operating the motor above 90°C (194°F) will shorten the life of the coil and the ball bearings. Motor case temperature can be measured by fastening a thermometer to the motor's surface, or with thermo-tape.
- Bring single-phase motors to a complete stop before switching the direction of rotation. If you try to switch the direction of rotation before the motor has stopped, it may not change or may require time.
- Use the provided capacitor for single-phase motors and always keep the capacitor connected after the motor is started.
- The three-phase 380/400/415 VAC motors cannot be combined with an inverter. If combined with an inverter, these motors may be damaged due to deteriorated insulation of the motor coil.

Time rating

This motor can be operated continuously (continuous rating).

Locked rotor burnout protection

This motor is equipped with a feature listed below to prevent the motor from burning out as a result of abnormal heating which may be caused by misapplication.

Thermal protection ("THERMALLY PROTECTED" is stamped on the motor nameplate)

When the motor reaches a predetermined temperature, the internal thermal protector is activated and the motor is stopped.

With the automatic resume feature, the motor automatically begins operating again as soon as the motor temperature falls.

Always turn the power off before performing inspections.

Thermal protector activation range:

Power is turned off at 150 °C±5 °C (302 °F±9 °F) [130 °C±5 °C (266 °F±9 °F)]*

Power is turned back on at 96 °C±15 °C (205 °F±27 °F) [83 °C±15 °C (181 °F±27 °F)]*

* [] indicates the value for the three-phase 380/400/415 VAC motors.

Troubleshooting

When the motor is not functioning normally, perform an inspection covering the points listed in the table below.

If the inspection shows that everything is normal but the motor and control unit still are not functioning correctly, contact the nearest ORIENTAL MOTOR office.

Problem	Things to check
The motor does not rotate or motor rotates at low speed.	<ul style="list-style-type: none"> Is the correct voltage being supplied to the motor? Are lead wires properly and firmly connected? Is the load too large? If lead wires have been extended by using a terminal strip or terminal block, are the lead wires properly and firmly connected at all points? For a single-phase motor, is the provided capacitor connected as shown in the connection diagram of p.5?
The motor sometimes rotates and stops.	<ul style="list-style-type: none"> Are lead wires properly and firmly connected? If lead wires have been extended by using a terminal strip or terminal block, are the lead wires properly and firmly connected at all points? For a single-phase motor, is the provided capacitor connected as shown in the connection diagram of p.5?
The motor rotates in the wrong direction.	<ul style="list-style-type: none"> Is the connected as shown in the connection diagram? Check the connection diagram of p.5 again. The gearhead output shaft's rotation direction differs depending on the gear ratio of the gearhead. For a single-phase motor, is the provided capacitor connected as shown in the connection diagram of p.5? Are you looking at the motor from the wrong side? Rotation is defined as viewed from the output shaftside.
The motor becomes extraordinarily hot (motor case temperature exceeds 90 °C (194 °F)).	<ul style="list-style-type: none"> Is the correct voltage being supplied to the motor? Does the ambient temperature exceed the specified range? For a single-phase motor, is the provided capacitor connected as shown in the connection diagram of p.5?
The motor makes a strange noise.	<ul style="list-style-type: none"> Are the motor and gearhead correctly fastened?

Specifications/ General specifications

Check on the Oriental Motor Website for the product specifications.

Regulations and standards

UL Standards, CSA Standards, CCC System

This product is recognized by UL under the UL and CSA Standards, and also certified by CQC under the China Compulsory Certification (CCC) system.

The motor model name represents the model that conforms to the standards.

The three-phase 380/400/415 VAC motors have obtained only the certification under the CCC system.

Applicable standards	Certification Body / File No.
UL 1004-1, UL 1004-3 CSA C22.2 No.100, CSA C22.2 No.77	UL/UL File No.E64197
GB/T 12350	CQC

- Thermal Class: 130 (B)

Standards for accessories

Capacitor: UL File No.E83671 (CYWT2)

Capacitor cap: UL File No.E56078 (YDTU2)

CE Marking

This product is affixed the CE Marking under the Low Voltage Directive.

Low Voltage Directive

Applicable standards

EN 60034-1, EN 60034-5, EN 60664-1, EN 60950-1

Installation conditions (For EN standard)

- Overvoltage category: II
- Pollution degree: 2
- Protection against electric shock: Class I equipment

When the machinery to which the motor is mounted requires overvoltage category III and pollution degree 3 specifications, install the motor in a cabinet that comply with IP54 and connect to power supply via an isolation transformer.

The motor with a terminal box requires overvoltage category III* and pollution degree 3 specifications (except for the motor installation surface of the round shaft type).

* If EN 60950-1 is required, Overvoltage category is II .

Motor temperature rise tests

Temperature rise tests required by the above standards are performed in a state that has been attached a gearhead or a heat radiation plate.

The size and material for the heat radiation plates are as follows.

Size [mm (in.)]	Thickness [mm (in.)]	Material
230x230 (9.06x9.06)	5 (0.20)	Aluminum alloy

Electrical appliance and material safety law

BHI62ST-A bears a  mark.

RoHS Directive

The products do not contain the substances exceeding the restriction values of RoHS Directive (2011/65/EU).

- Unauthorized reproduction or copying of all or part of this manual is prohibited.
- Oriental Motor shall not be liable whatsoever for any problems relating to industrial property rights arising from use of any information, circuit, equipment or device provided or referenced in this manual.
- Characteristics, specifications and dimensions are subject to change without notice.
- While we make every effort to offer accurate information in the manual, we welcome your input. Should you find unclear descriptions, errors or omissions, please contact the nearest office.
- Oriental motor** is a registered trademark or trademark of Oriental Motor Co., Ltd., in Japan and other countries.

© Copyright ORIENTAL MOTOR CO., LTD. 2011

Published in March 2020

* Please contact your nearest Oriental Motor office for further information.

ORIENTAL MOTOR U.S.A. CORP.
Technical Support Tel:(800)468-3982
8:30 A.M. to 5:00 P.M., P.S.T. (M-F)
7:30 A.M. to 5:00 P.M., C.S.T. (M-F)
www.orientalmotor.com

ORIENTAL MOTOR DO BRASIL LTDA.
Tel:+55-11-3266-6018
www.orientalmotor.com.br

ORIENTAL MOTOR (EUROPA) GmbH
Schiesstraße 44, 40549 Düsseldorf, Germany
Technical Support Tel:00 800/22 55 66 22
www.orientalmotor.de

ORIENTAL MOTOR (UK) LTD.
Tel:01256-347090
www.oriental-motor.co.uk

ORIENTAL MOTOR (FRANCE) SARL
Tel:01 47 86 97 50
www.orientalmotor.fr

ORIENTAL MOTOR ITALIA s.r.l.
Tel:02-93906346
www.orientalmotor.it

ORIENTAL MOTOR CO., LTD.
4-8-1 Higashiueno, Taito-ku, Tokyo 110-8536
Japan
Tel:03-6744-0361
www.orientalmotor.co.jp

ORIENTAL MOTOR ASIA PACIFIC PTE. LTD.
Singapore
Tel:1800-8420280
www.orientalmotor.com.sg

ORIENTAL MOTOR (MALAYSIA) SDN. BHD.
Tel:1800-806161
www.orientalmotor.com.my

ORIENTAL MOTOR (THAILAND) CO., LTD.
Tel:1800-888-881
www.orientalmotor.co.th

ORIENTAL MOTOR (INDIA) PVT. LTD.
Tel:+91-80-41125586
www.orientalmotor.co.in

TAIWAN ORIENTAL MOTOR CO., LTD.
Tel:0800-060708
www.orientalmotor.com.tw

SHANGHAI ORIENTAL MOTOR CO., LTD.
Tel:400-820-6516
www.orientalmotor.com.cn

INA ORIENTAL MOTOR CO., LTD.
Korea
Tel:080-777-2042
www.inaom.co.kr

ORIENTAL MOTOR CO., LTD.
Hong Kong Branch
Tel:+852-2427-9800